



P Series PiezoJet Printer



Coding for Industry 4.0

[Increased productivity]

Less manual intervention to meet high-efficiency production

[Reliability]

Stable constant temperature ink supply system

[Flexibility]

Compatible with multiple printheads for large-format printing

P7 Pro : 71mm

CAUTION!

PACKAGE HANDLING SYMBOLS



P5 Pro: 54mm

Nutrition Facts



Calories 415 kJ / 98 KCal		Protein 0g	
% Daily Value*		%	
Total Fat	0%	Vitamin A	0%
Saturated Fat	0%	Vitamin B	0%
Trans Fat	0%	Vitamin C	0%
Cholesterol 0 mg	0%	Vitamin D	0%
Sodium 0mg	0%	Calcium 0g	0%
Total Carbohydrate 0mg	0%		
Sugars	0%		

P3 Pro : 36mm

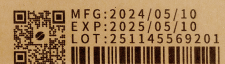

Coding Tomorrow

www.LeadTech-NA.com
LEAD TECH-North America



Specifications

Model	P3 Pro	P5 Pro	P7 Pro
Printhead	Konica KM512	RICOH MH5420	SEIKO 510
Operating System	LT-Touch Android Operation System		
Max. Line Speed	Max. 180.44ft (55m/min)	Max. 853.01ft (260m)/min	Max. 180.44ft (55m/min)
Print Distance (Recommended)	9.84' - 16.40' (3-5mm)		
Print Resolution	Vertical:360 DPI Horizontal:180 DPI	Vertical:150/300/600 DPI Horizontal:150/300/600 DPI	Vertical:180 DPI Horizontal:180/360 DPI
Ink System	Negative Pressure Ink Supply		
Print Height	1.42" (36mm)	2.13" (54mm)	2.83" (71.8mm)
Communication	Ethernet, USB, RS232, Photocell, Encoder, Alarm Lamp		
User Interface	10.2 inch Industrial Touch Screen		
Power	100-120/200-240V~,99W		
System Language	English, Chinese, Italian, Spanish, Russian and other languages can be upgraded		
Print Message	Text, Variable Text, Date, Time, Shift, Counter, Database Text, Barcode, Graphics, Tables and QR Codes		
Support Database Type	TXT, Excel, Access, SQL Server		
Installation	Sideward and Downward Printing with Standard Bracket, Optional Precise Adjustable Bracket		
Ink Type	Oil based and UV ink		
Ink Management	Auto-identify Ink Type and Confirm Optimal Parameter, Auto-calculate Ink Consumption		
Operating Environment	59°F(15°C) - 104°F(40°C)		
Storage Environment	41°F(5°C) - 113°F(45°C)		
Printhead Specification	15.46"x5.63"x2.20" (392.75x143x56mm)	15.46"x6.65"x2.20" 392.75x169x56mm	12.71"x6.65"x2.20" 322.75x169x56mm

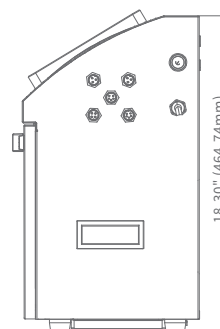
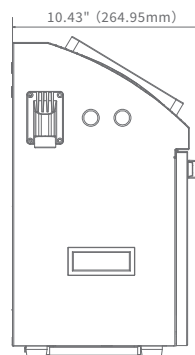
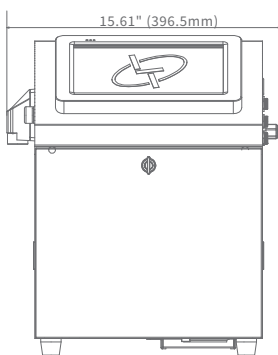
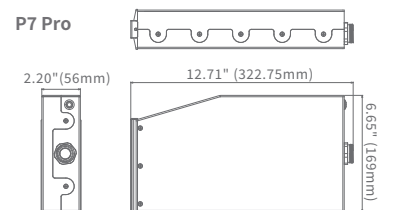
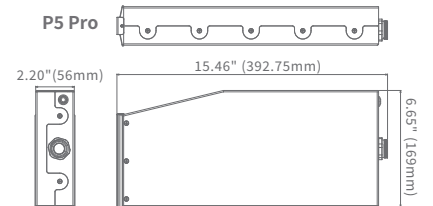
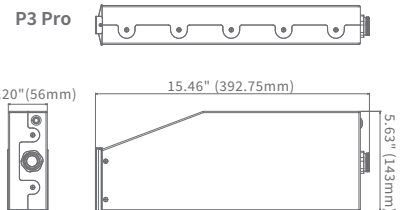
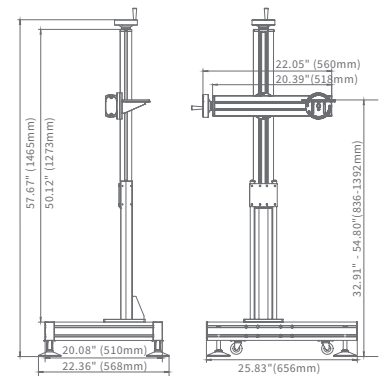

LEAD TECH-North America



Tel: 507-701-6786
 Email: Support@LeadTech-NA.com
 Web: www.LeadTech-NA.com
 Address: 300 3rd St SE Ste 6 Rochester MN 55904